

Waggz®

Built to impress and ready to work – equipment by and for pet groomers

WZ-230E / WZ-230E-BLK / WZ-230EL / WZ-230EL-BLK User Manual

Waggz Power-Lift

Electric Tub with Lift-Out Door
WZ-230E White and Black



Waggz XL Power-Lift

XL Electric Tub with Lift-Out Door
WZ-230EL White and Black



The image shown here is indicative only. If there is inconsistency between the image and the actual product, the actual product shall govern.

1. TECHNICAL SPECS

WZ-230E White and Black

Basin Size	50 x 28.75 in 、 127 x 73 cm	Door Style	Lift out
Adjustable Height	13 – 37 in 、 33 – 94 cm	Door Width	16 inches 、 40.6 cm
Height Change Speed	0.7 in/s 、 1.8 cm/s	Frame Material	Powder-coated stainless steel
Lift Mechanism	Denmark Electric Actuator 6000N	Power Rating	110 – 240V 、 Max 8A / 190W
Max Weight Capacity	275 lb 、 125 kg	Product Net Weight	308 lb 、 140 kg (4-person lift)

WZ-230EL White and Black

Basin Size	60 x 28.75 in 、 152.4 x 73 cm	Door Style	Lift out
Adjustable Height	13 – 37 in 、 33 – 94 cm	Door Width	20 inches 、 50.8 cm
Height Change Speed	0.7 in/s 、 1.8 cm/s	Frame Material	Powder-coated stainless steel
Lift Mechanism	Denmark Electric Actuator 6000N	Power Rating	110 – 240V 、 Max 8A / 190W
Max Weight Capacity	275 lb 、 125 kg	Product Net Weight	352 lb 、 160 kg (6-person lift)

2. CONTACT INFORMATION

Thank you for your purchase! This quick-start guide will help you get the most out of your new Waggz grooming tub. If you have any questions, need replacement parts, or want to purchase additional products, just get in touch!

Visit 910 Canal Pl, City of Industry, CA 91746
Call 626-549-1212
Email info@waggz.com
Follow @waggzgrooming

3. GENERAL GUIDANCE

UPON ARRIVAL

Please carefully examine your grooming tub and review the packing list. If you notice any missing parts or damaged components, notify Waggz immediately.

Do not attempt to disassemble the table before contacting Waggz.

CLEANING, CARE, AND MAINTENANCE

Waggz grooming tubs are built to impress and ready to work. Regular cleaning and routine maintenance will keep it that way! Follow these steps to extend the life of your tub and protect your Waggz 2-year warranty:

WORKING CONDITIONS

Cool-down periods: rest for 18 minutes after 2 minutes of continuous lifting and lowering

Temperature: avoid extreme cold (<40°F) and extreme heat (>104°F)

Humidity: avoid extreme dryness (<20%) and extreme humidity (>90%)

Altitude: avoid extreme altitudes (1.86 miles above sea level)

Air pressure: performs best between 700 and 1060 hPA

DAILY CLEANING

Remove hair and dander from the tub, then wipe clean with a mild detergent. Please avoid using anti-grease detergents and citrus-based cleansers, which may damage the finish on your tub. Stains should be promptly treated with 1 part ethyl alcohol to 20 parts water, then rinse well. Dry all surfaces between uses.

QUARTERLY INSPECTION

- Complete a visual inspection of all equipment, including controls and hydraulic mechanism
- Check the tightness and state of wear on all screws, bolts, bushings, and pins
- Check for leaks, then wipe off any lubrication residue around gas springs and pistons
- Check the stability and installation of all adjustable components
- Observe the lift mechanism to check for unusual sounds, vibrations, and oscillations

NON-ROUTINE MAINTENANCE











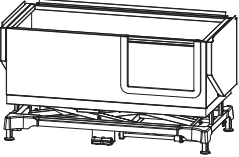



- For safety reasons and to avoid invalidating the warranty, Waggz alone must diagnose and organize action for any faults relating to the hydraulic pistons and electronic lift system.
- Maintenance technicians must be familiar with the contents of this instruction booklet and may only use original Waggz parts and components.
- Always complete a full safety inspection of the tub after rough handling, falls, drops, or bumps.



WARNING

- IF YOU EVER HAVE SAFETY CONCERNS ABOUT THE CONDITION OF COMPONENTS, IMMEDIATELY DISABLE THE EQUIPMENT TO PREVENT USE UNTIL SAFETY RISKS HAVE BEEN REMOVED OR RESOLVED.
- IMMEDIATELY RECORD AND REPORT ANY DEFECTS OR DAMAGES DIRECTLY TO THE MANUFACTURER.

3. PACKING LIST

A  Grooming tub with control pedals, 1 class II control box, 1 electric actuator, 3 folding splash guards, and 4 adjustable feet X1 set	B  Metal storage shelves X2 sets	C  Left floor basin cover X1 set	D  Right floor basin cover X1 set	E  Thermostati shower faucet X1 set	F  Adjustable shower head X1 set		
G  56-inch shower hose X1 set	H  Shower head holder and screws X1 set	I  59-inch water hoses X2 sets	J  4/6 tap connectors X2 sets	K  62-inch drainpipe X1 set	L  Overflow pipe X1 set	M  3-part hair filter and drain X1 set	N  Grooming loop hooks X3 sets

4. ASSEMBLY INSTRUCTIONS

STEP 1 : assembly

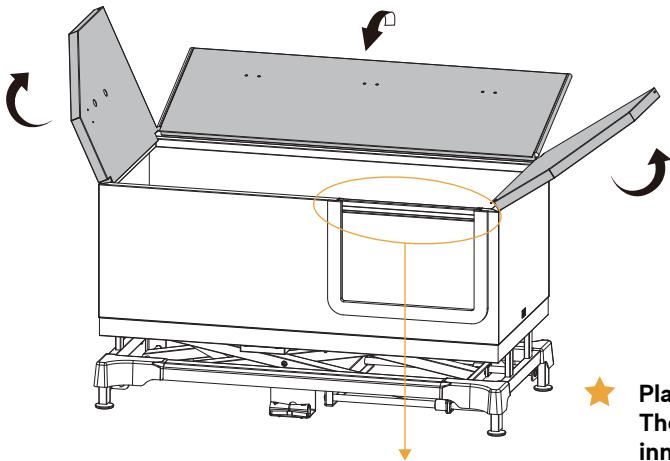

★ Lift folding splash guards and lock in upright position.

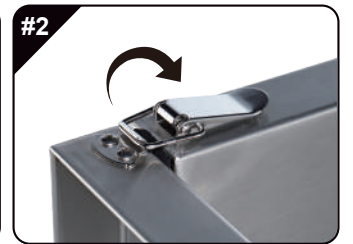
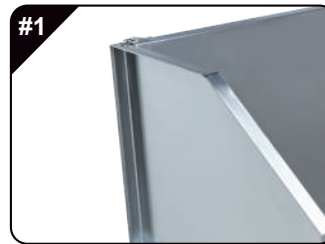

★ Place floor basin covers in the bottom of the tub. These grates can also be used as puppy boosters, when elevated on the inner rail.

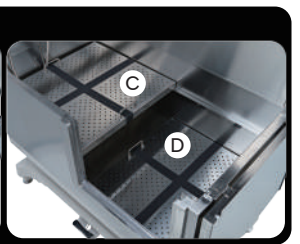
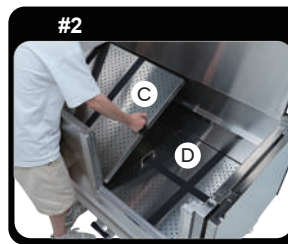
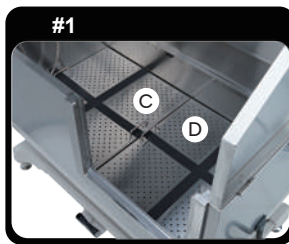

STEP 2 : elevation

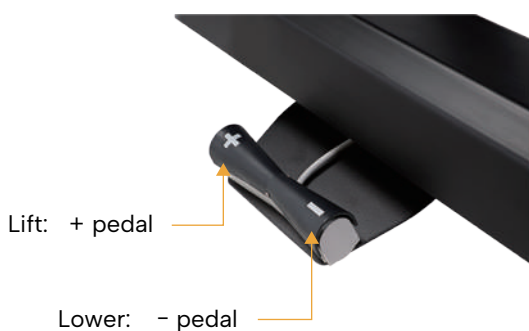

STEP 3 : accessories



★ Notes:

1. The standard hot and cold water hoses in this kit are 59 inches long. If your water lines are more than 59 inches away, we recommend purchasing an extended water pipe adapter.
2. Please match the hot and cold water lines and hoses with the matching faucet inlets, as marked in the diagram.
3. To prevent damage and ensure proper drainage, the drain hose must be positioned around the outside of the frame.

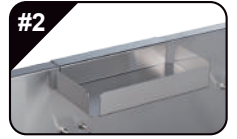
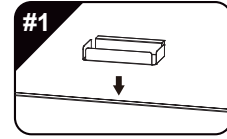
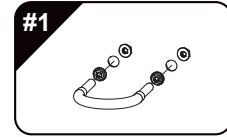
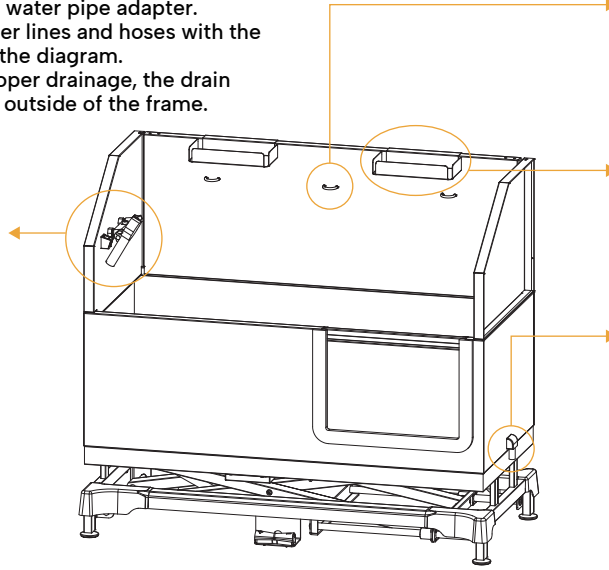
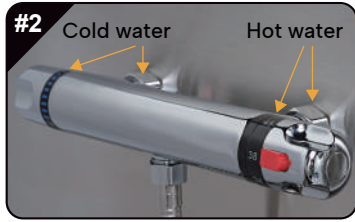
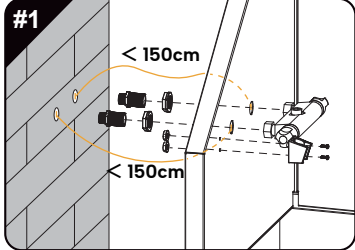

★ Pay attention to drainage pipe position, it could only connect to floor drain hole going under bottom frame exteriorly. ✓ =Correct ✗ =Wrong



Safety Tips:

1. Check space between the splash guards and ceiling before raising the tub to full height.
2. Look for objects and obstructions under the tub before lowering or adjusting height.
3. Adjust and stabilize feet for even balance before loading animals into the tub.

**** NEVER LEAVE ANIMALS ON UNATTENDED. ALWAYS MONITOR FOR SAFETY ****

5. TABLE DIMENSIONS

Power-Lift WZ-230E



Power-Lift XL WZ-230EL

