

# Waggz®

Built to impress and ready to work – equipment by and for pet groomers

## WZ-908P / WZ-908P-BLK / WZ-999P / WZ-999P-BLK User Manual

### Waggz Store-Low

Electric Table with Drawers and Outlets  
WZ-908P White and Black



### Waggz Store-Range

XL Electric Table with Drawers and Outlets  
WZ-999P White and Black



## 1. TECHNICAL SPECS

### WZ-908P White and Black

<b>Table Height</b> (excluding arm)	16.5 – 46 in 、 41.9 – 116.8 cm	<b>Tabletop Size</b>	50 x 26 x 0.47 in 、 127 x 66 x 1.2 cm
<b>Height Change Speed</b>	0.8 in/s 、 2 cm/s	<b>Tabletop Material</b>	Solid wood with non-slip rubber top
<b>Lift Mechanism</b>	Denmark Electric Actuator 6000N	<b>Power Rating</b>	110 – 240V 、 Max 8A / 190W
<b>Max Weight Capacity</b>	265 lb 、 120 kg	<b>Product Net Weight</b>	176 lb 、 70 kg
<b>Battery Capacity</b>	24 V / 1.3AhV 、 Max Current: 5A	<b>Battery Type</b>	Sealed Lead Acid Battery
<b>Plug Maximums</b>	1500W power 、 12A current	<b>Flammability Rating</b>	UL94V-2

### WZ-999P White and Black

<b>Table Height</b> (excluding arm)	16 – 50 in 、 40.6 – 127 cm	<b>Tabletop Size</b>	52 x 26 x 0.47 in 、 132.1 x 66 x 1.2 cm
<b>Height Change Speed</b>	0.75 in/s 、 2 cm/s	<b>Tabletop Material</b>	Solid wood with non-slip rubber top
<b>Lift Mechanism</b>	Denmark Electric Actuator 6000N	<b>Power Rating</b>	110 – 240V 、 Max 8A / 190W
<b>Max Weight Capacity</b>	265 lb 、 120 kg	<b>Product Net Weight</b>	183 lb 、 83 kg
<b>Battery Capacity</b>	24 V / 1.3AhV 、 Max Current: 5A	<b>Battery Type</b>	Sealed Lead Acid Battery
<b>Plug Maximums</b>	1500W power 、 12A current	<b>Flammability Rating</b>	UL94V-2

## 2. CONTACT INFORMATION

Thank you for your purchase! This quick-start guide will help you get the most out of your new Waggz grooming table. If you have any questions, need replacement parts, or want to purchase additional products, just get in touch. We're here to help:

**Visit** 910 Canal Pl, City of Industry, CA 91746  
**Call** 626-549-1212  
**Email** info@waggz.com  
**Follow** @waggzgrooming

## 3. GENERAL GUIDANCE

### UPON ARRIVAL

Please carefully examine your grooming table and review the packing list. If you notice any missing parts or damaged components, notify Waggz immediately.

**Do not attempt to disassemble the table before contacting Waggz.**

### CLEANING, CARE, AND MAINTENANCE

Waggz grooming tables are built to impress and ready to work. Regular cleaning and routine maintenance will keep it that way! Follow these steps to extend the life of your table and protect your Waggz 2-year warranty:

### WORKING CONDITIONS

**Cool-down periods:** rest for 18 minutes after 2 minutes of continuous lifting and lowering

**Battery charging:** plug in for 6 to 8 hours to fully charge the portable battery before use

**Temperature:** avoid extreme cold (<40°F) and extreme heat (>104°F)

**Humidity:** avoid extreme dryness (<20%) and extreme humidity (>90%)

**Altitude:** avoid extreme altitudes (1.86 miles above sea level)

**Air pressure:** performs best between 700 and 1060 hPA

### DAILY CLEANING

Use a damp cloth or soft brush and neutral detergent to clean the tabletop. Stains should be promptly treated with 1 part ethyl alcohol to 20 parts water, then rinse well.

### QUARTERLY INSPECTION

- Complete a visual inspection of all equipment, including controls and hydraulic mechanism
- Check the tightness and state of wear on all screws, bolts, bushings, and pins
- Check for leaks, then wipe off any lubrication residue around gas springs and pistons
- Check the stability and installation of all adjustable components
- Observe the lift mechanism to check for unusual sounds, vibrations, and oscillations

### NON-ROUTINE MAINTENANCE











- For safety reasons and to avoid invalidating the warranty, Waggz alone must diagnose and organize action for any faults relating to the hydraulic pistons and electronic lift system.
- Maintenance technicians must be familiar with the contents of this instruction booklet and may only use original Waggz parts and components.
- Always complete a full safety inspection of the table after rough handling, falls, drops, or bumps.



## WARNING

- IF YOU EVER HAVE SAFETY CONCERNS ABOUT THE CONDITION OF COMPONENTS, IMMEDIATELY DISABLE THE EQUIPMENT TO PREVENT USE UNTIL SAFETY RISKS HAVE BEEN REMOVED OR RESOLVED.
- IMMEDIATELY RECORD AND REPORT ANY DEFECTS OR DAMAGES DIRECTLY TO THE MANUFACTURER.

## 4. PACKING LIST

<p><b>A</b></p>  <p>Grooming table with 2 control pedals, 1 class II control box, 1 electric actuator, 1 lead acid battery, and 4 adjustable feet X1 set</p>	<p><b>B</b></p>  <p>Adjustable grooming arm X2 sets</p>	<p><b>C</b></p>  <p>Nylon grooming loop X4 pcs</p>	<p><b>D</b></p>  <p>Allen key X1 pc</p>		
<p><b>E</b></p>  <p>Spring washers X8 pcs</p>	<p><b>F</b></p>  <p>Flat metal washers X8 pcs</p>	<p><b>G</b></p>  <p>8x12mm screws X8 pcs</p>	<p><b>H</b></p>  <p>Non-slip drawer mats X4 pcs</p>	<p><b>I</b></p>  <p>Left shelf mat X1 pc</p>	<p><b>J</b></p>  <p>Right shelf mat X1 pc</p>

## 5. ASSEMBLY INSTRUCTIONS

### STEP 1

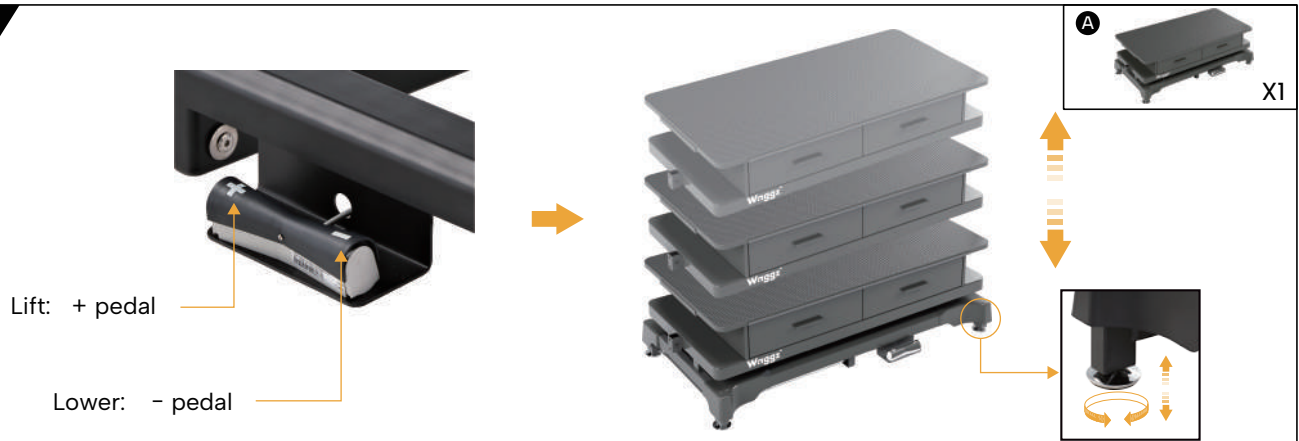

### STEP 2

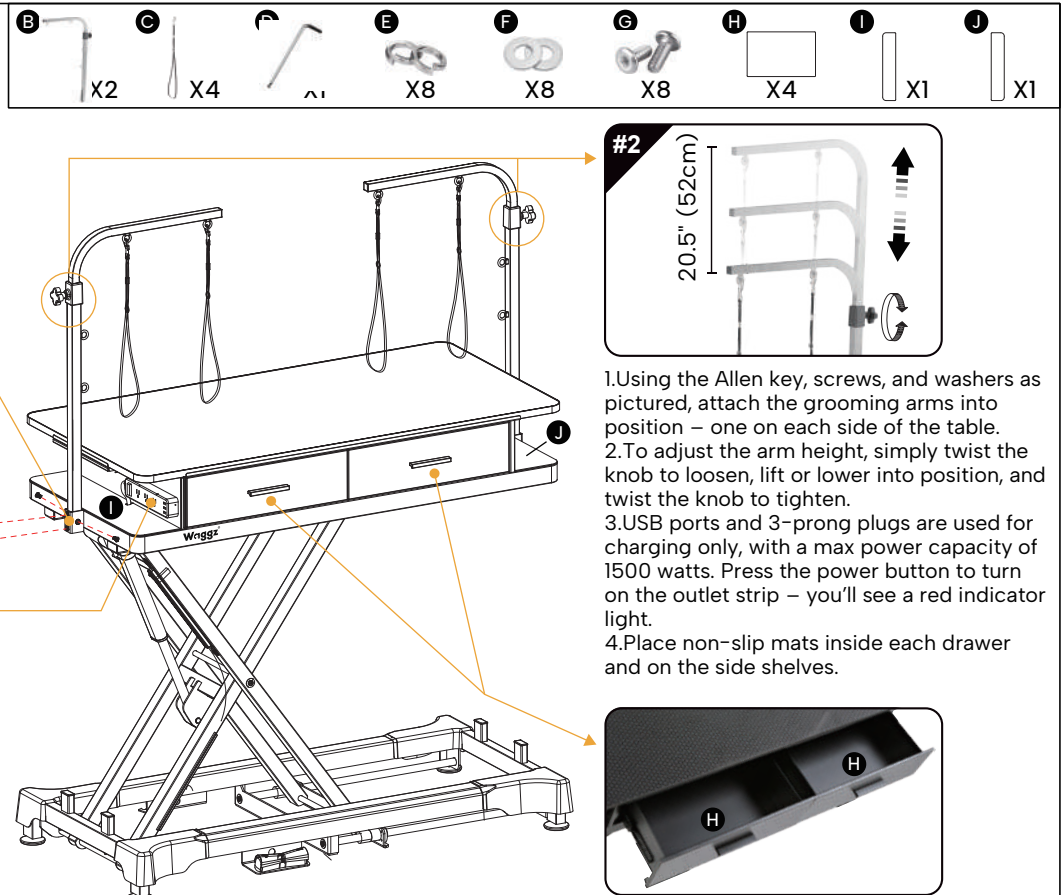

**Safety Tips:**

- 1. Check space between the grooming arms and ceiling before raising the table to full height.
- 2. Support the grooming arm with one hand while loosening the knob and adjusting height.
- 3. Look for objects and obstructions under the table before lowering or adjusting height.
- 4. Adjust and stabilize feet for even balance before loading animals onto the table.

**\*\* NEVER LEAVE ANIMALS ON UNATTENDED. ALWAYS MONITOR FOR SAFETY \*\***

## 6. TABLE DIMENSIONS

### Store-Low WZ-908P

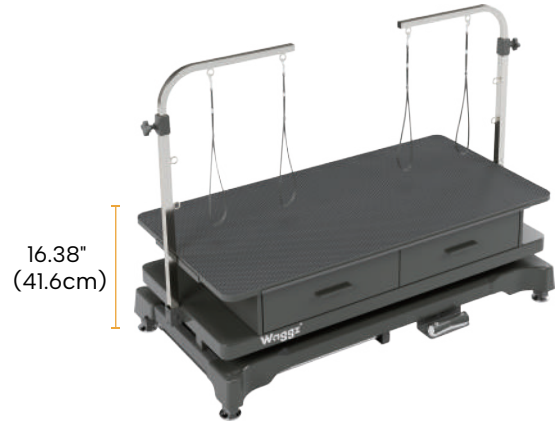
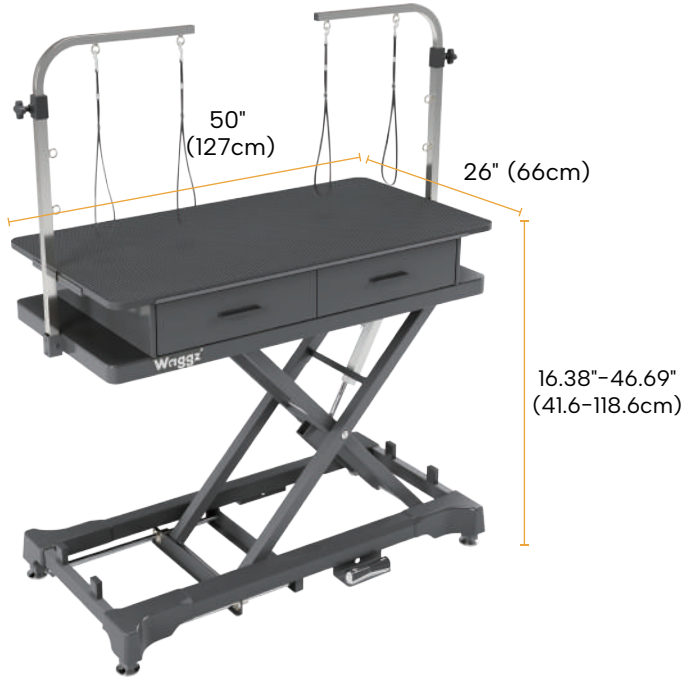

### Store-Range WZ-999P

